



A REVOLUTIONARY STEP IN LASER MEASUREMENT



THE GAPGUN PRO PROVIDES UNRIVALLED LEVELS OF PERFORMANCE AND PROFILE MEASUREMENT CAPABILITIES

Ultra fast measurement capability

GapGun Pro's superfast processor means that measurements can be collected faster than ever before, with speed improvements of up to 20x over manual techniques, reducing cycle time and increasing efficiency.

Unrivalled connectivity options

GapGun Pro stores data internally as it measures and automatically connects to Wi-Fi for seamless productivity. Results can be downloaded at any time using integrated wireless link, USB port or docking station.

Best user interface on the market

Full colour graphical checkplans show operators how and where to measure. On-screen compass and colour coding guides positioning relative to the part, whilst sounds and vibrations alert operators of in/out tolerance conditions.

Completely portable for operator flexibility

GapGun Pro can operate completely standalone for around 4 hours with its high capacity internal battery, taking measurements with the same accuracy, reliability and performance as when tethered to a PC. For a further 6.5 hours autonomous use, simply attach it to its lightweight clip on battery pack.

High resolution & precision measurement capability

GapGun Pro can be specified with multiple field of view and resolution VChange sensor, to take a wide range of measurements. GapGun Pro gives real world repeatability of 10µm or maximum feature size of 40mm.

Ergonomic and robust design

GapGun Pro's highly ergonomic and lightweight design means that operators can easily use one handed. The rugged construction and shock protection sensor jacket makes it durable in a wide range of manufacturing environments.



Features

left Side

12:35
72%



Proton



Works orders 150
924

Tools

Measurement Plan

Audi Bonnet

Audi Left Side

Audi Inside

THE GAPGUN PRO COMES EQUIPPED WITH A MARKET LEADING RANGE OF FEATURES



High resolution touch screen

The GapGun Pro's large colour touch screen is highly responsive, easy to navigate and best on the market, with 4x the resolution than that of previous GapGun models. Readable in a huge array of conditions, the high definition screen displays measurement instructions, results and analysis.



VChange sensors with Hi-Range capability

VChange sensors have a Hi-Range measurements capability which dynamically adjusts laser output to allow measurement on multiple surface conditions. GapGun Pro can measure anything from carbon fibre to high gloss black paint and chromes.



Pre-configured & customisable

The GapGun Pro comes ready configured to measure a wide variety of common applications. You can create your own infinite variations on these initial building blocks.



On screen results analysis

View cross sections of the measurement area and results analysis on-screen using standard red/green colouring conventions and warning sounds to indicate go/no go conditions.



Export results easily

GapGun Pro can fully customise its output and export results easily to CSV, SQL, XML, Excel, PDF and other file formats, as well as interface with most leading SPC packages such as QDAS.



Share measurement planning

GapGun Pro connects to SPC3d and shares with multiple GapGuns, to create bespoke Virtual Tools and graphical measurement checkplans for complex applications.



Fully integrated Wi-Fi capability

GapGun Pro has a fully integrated Wi-Fi connection for totally autonomous measurement capability. This means it's possible to achieve instant results access direct to the PC with no additional hardware or cables required, giving operators enhanced portability and convenience on the shop floor.



Multipurpose desk dock

Used to download measurement plans and upload results data between the PC and the GapGun Pro, the desk dock is also an ideal place to dock and charge the GapGun Pro whilst not in use.



GAP & FLUSH

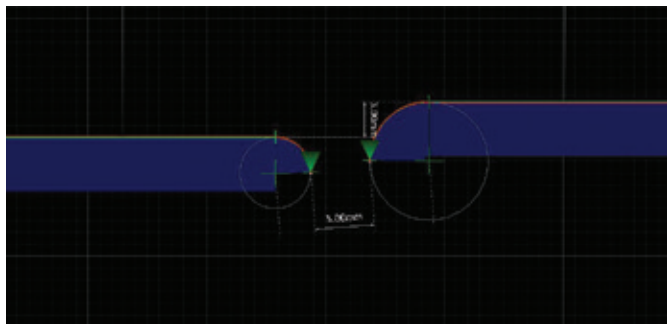

RADIUS

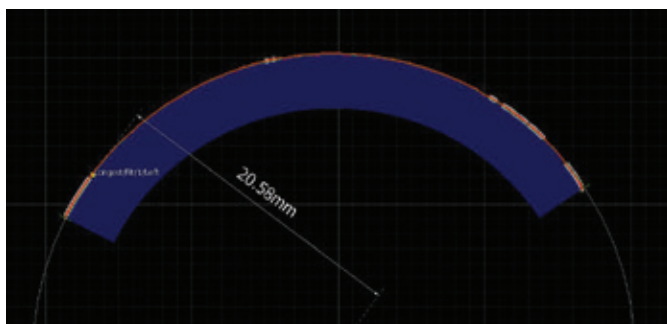

EDGE BREAK

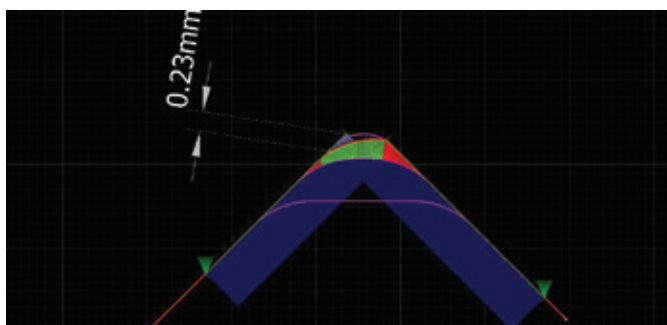

SCRATCH





BURR

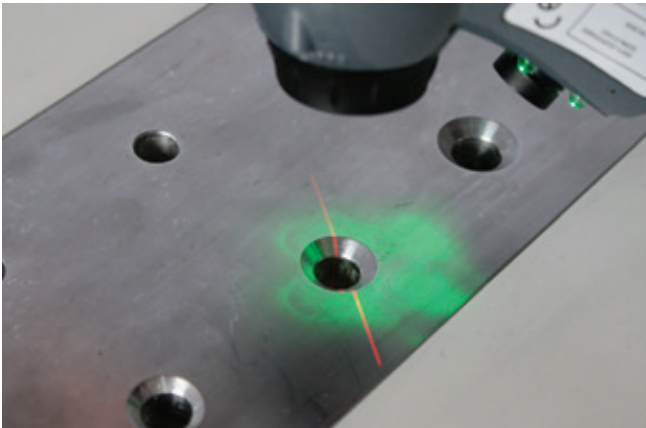
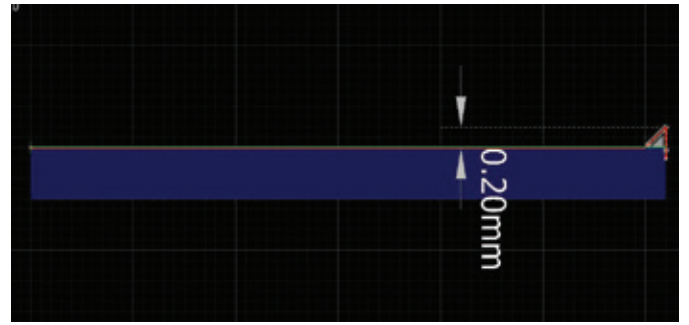

COUNTERSINK

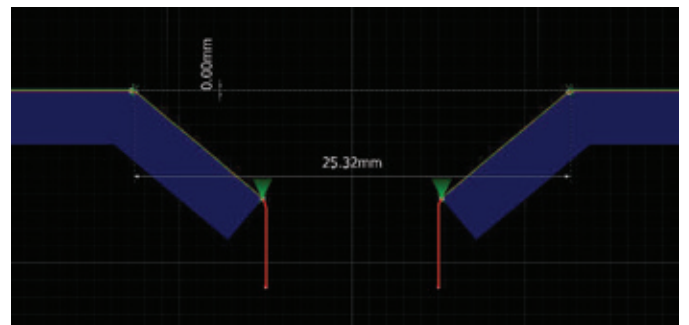

WELD & SEAL

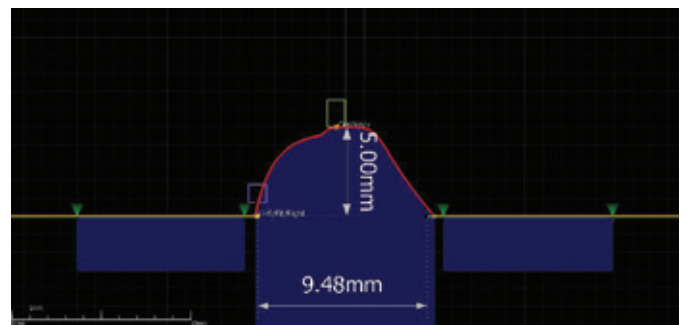

ANGLE

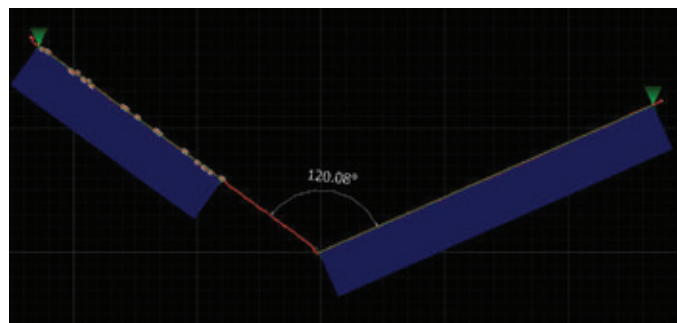



MAXIMISE YOUR ACCURACY AND REPEATABILITY

The GapGun Pro system comes equipped to operate either non-contact (no stand-offs) or contact (with stand-offs). Because adding or removing the standoffs takes only seconds, you can maximise performance by selecting the best method for each measurement point.

USE THE GAPGUN PRO WITHOUT STAND-OFFS (NON-CONTACT)

- On any surfaces that are soft, plastic, or may move
- Where surface damage is a concern
- For hard to reach, concave, or restricted areas.



OTHERWISE, USE THE GAPGUN PRO WITH STAND-OFFS (CONTACT)

- For measuring at arms length or on small complex features
- Where an application specific stand-off is used
- To train new operators and reduce operator uncertainty.



THE VCHANGE SENSOR HEADS

GapGun Pro includes Third Dimension's ergonomic VChange sensor interface, which allows the operator to remove, swap and reattach sensor heads, in just seconds, making multiple sensor use on the shop floor easier than ever before.



The VChange sensor system

ADJUSTABLE LASER CAP

Third Dimension's Hi-Range sensor technology enables a multitude of challenging surface finishes to be measured. Its patented adjustable laser cap can uniquely shorten or split the laser line to measure a range of complex features.



Split laser line adjustment, small laser line adjustment, long laser line.

SENSOR HEAD TECHNICAL SPECIFICATION

SENSOR HEAD TYPES

Third Dimension's extensive range of interchangeable VChange sensor heads mean a vast range of measurements can be collected using just one system. GapGun Pro's uniquely modular design enables the customer to interchange sensors for 4 different fields of view.



1. FOV7: SUPER HIGH RESOLUTION

TYPICAL FEATURE SIZE RANGE
0.1mm - 3.0mm

Scratches, defects, fasteners, chamfers and profiles, turbine blades, small gap and flush, radii.



2. FOV15: HIGH RESOLUTION

TYPICAL FEATURE SIZE RANGE
1mm - 5mm

Aerospace high accuracy gap and flush, large fasteners.



3. FOV40: STANDARD

TYPICAL FEATURE SIZE RANGE
2mm - 25mm

Generic, automotive or aerospace gap and flush, interiors, sealants, ring gauges.



4. FOV80: WIDE ANGLE

TYPICAL FEATURE SIZE RANGE
5mm - 40mm

Large gap and flush, profile measurement, CAD verification.



For more information, contact sales@third.com

SENSOR HEAD

Laser	Class 2M with automatic laser intensity adjustment.
Measurement capability	Defined by specification D05031. Sensor heads include a calibration and certificate.
Accuracy	Meets Cg, Cgk, 6-Sigma and VDAS standards for intended applications
Repeatability	Proven to <15% QS9000 MSA for a wide variety of measurement
Surface capability	U series: Automotive paints, unpolished and galvanised metals including steel and aluminium, plastics and soft furnishings. <i>Available as any VChange sensor head.</i> M Series: Carbon fibre, glass and mirrored surfaces. <i>Available as FOV7 & FOV15 VChange sensor heads only.</i>
Size	65 x 105 x 60mm (2.6 x 4.1 x 2.4") W x D x H
Weight	160g (5oz)

ACCESSORIES

Optional	Shock protection sensor head jacket and generic standoff set Sensor head extension cable and customisable standoff set
----------	---

GAPGUN TECHNICAL SPECIFICATION





HANDLE

Power rating	6W (12V @ 0.5A)
Screen	97mm (3.8") Daylight readable, full colour, high resolution LCD touchscreen 640 x 480px
User Interface	Click and drag touchscreen, trigger and power/reset button
Feedback	Audio output and haptic feedback
Storage capacity	2GB internal storage
Peripheral devices	USB 2.0 port
IP rating	IP50
Ethernet	100Mbps Fast ethernet (100BaseTX)
Wireless	IEEE 802.11 b,g,n <i>(Subject to local regulations and restrictions)</i>
Operating temperature	0 to 40C (32 to 104F). Internal battery charging limited at higher temperatures.
Storage Temperature	-20 to 60C (-4 to 140F)
Size	90 x 135 x 190mm (3.5 x 5.3 x 7.5") W x D x H
Weight	480g (17oz)
Software	GapGun version 7 software
Shock protection	Shock protecting cover on sensor and handle, and high impact plastic housing.

ACCESSORIES

Included	Dock station, clip on battery pack, battery, battery charger, calibration block holder and sample artefact, USB stick, belt clip and anti-static brush
Optional	Sensor head extension cable

COMPATIBLE PC SOFTWARE

	SPC3d Software Pack: for configuring Virtual measurement tools, data logging, reviewing measurements
	Inspect Software Pack: for manual and interactive analysis of measurement data
	Link Software Pack: allows custom .NET programs to be written controlling the GapGun or Vectro Devices.
	Inline Software Pack: allows a large overhead display of measured results

All software packages support international languages and regions.

WARRANTY AND SERVICE

Maintenance and service	1 year warranty as standard. Further options and details available from your local distributor.
-------------------------	---

WANT TO KNOW MORE ABOUT OUR MARKET LEADING GAPGUN PRO?

CALL : +44 (0)3333 443 000
EMAIL : info@third.com
VISIT : www.third.com

 @thegapgun

 ThirdDim

 third-dimension

OUR CUSTOMERS

Our distribution network serves customers in 30 countries worldwide. These include:



Lamborghini

Ferrari



Vestas

SIEMENS

RENAULT NISSAN



ASTON MARTIN



SAMSUNG

TOYOTA



Electrolux

Rolls-Royce

BOMBARDIER



EMBRAER

GapGun systems are designed, developed and manufactured by:

THIRD DIMENSION
ADVANCING MANUFACTURING

Authorised dealer